

## Flexible Dimming Solution by PWM / 0-10V / Potentiometer

REV. 00

### General Description

The LD8116B contains a processor which can convert the three different inputs of dimmer type include 0~10V DC potential, 0~100% duty cycle PWM (Plus Width Modulation) signal and potentiometer become a PWM signal output. It is easy to provide the isolation dimming control that via opto-coupler for smart LED lighting application.

The device features include wide input voltage from 13V to 58V, adjustable bias current source for potentiometer and high precision LED dimming current.

The LD8116A is the SOT-26 package to minimize the PCB size as well as component counts.

### Features

- Wide VCC operating range
- Low operation current
- Precision dimmer type with
  - Voltage potential : 0/1V to 10V
  - PWM dimming : 0.2k to 10kHz
  - Potentiometer : 0 to 10k Ohm.
- Adjustable bias current source of DIM pin
- Adjustable minimum output PWM duty clamping
- Built in over temperature protection for Chip

### Applications

- Dimmable LED Power Supply
- Dimming Devices

### Typical Application

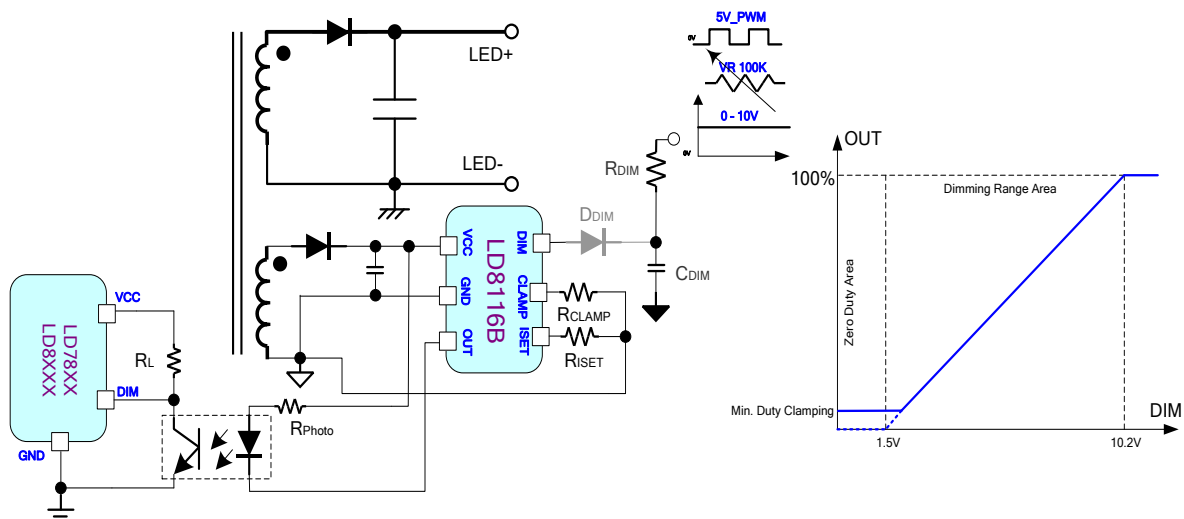
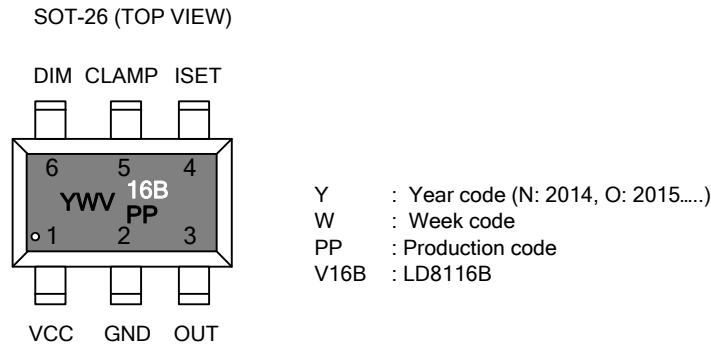

Fig. 1 Application Circuit

## Pin Configuration



## Ordering Information

Part number	Package	Top Mark	Shipping
LD8116B GL	SOT-26	YWV/16B	3000 /tape & reel

The LD8116BGL is ROHS compliant/ green packaged

## Protection Mode

Part number	Internal OTP
LD8116B GL	Auto-recovery

## Pin Descriptions

Pin	NAME	FUNCTION
1	VCC	Supply voltage pin.
2	GND	Ground or Power return pin.
3	OUT	This pin is dimming output. It's an open-drain configuration. Connect this pin to power supply by a resistor.
4	ISET	This pin is used to set bias current of DIM pin by a resistor (= $R_{ISET}$ ) connected between this pin and GND.
5	CLAMP	This pin is used to set minimum output clamped duty cycle by a resistor (= $R_{CLAMP}$ ) connected between this pin and GND.
6	DIM	Dimming signal input; - Voltage Potential : 0/1V to 10V - PWM Dimming : 0.2k to 10kHz and amplitude is upper 3.2V - Potentiometer : 0 to 100k ohm

## Block Diagram

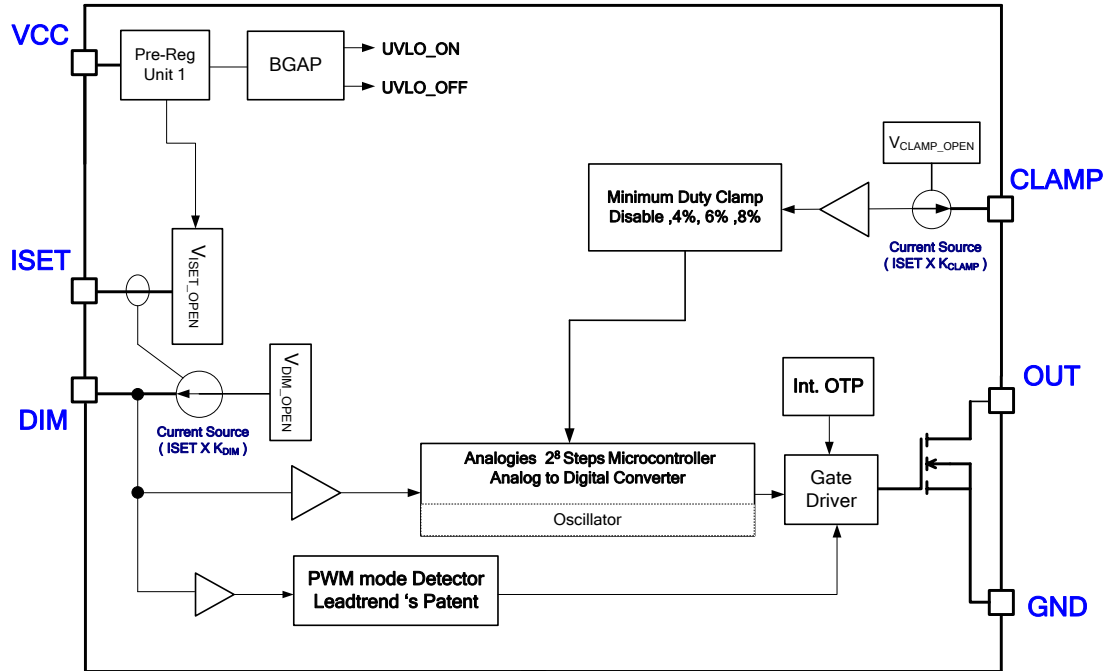

## Absolute Maximum Ratings

VCC.....	-0.3V~60V
OUT.....	-0.3V~60V
OUT Sink Current .....	30mA
DIM.....	-0.3V~20V
ISET, CLAMP.....	-0.3V~6V
Maximum Junction Temperature .....	150°C
Storage Temperature Range.....	-65°C ~ 150°C
Package Thermal Resistance (SOT-26, $\theta_{JA}$ ).....	200°C/W
Power Dissipation (SOT-26, at Ambient Temperature = 85°C).....	200mW
Lead temperature (Soldering, 10sec).....	260°C
ESD Voltage Protection, Human Body Model .....	2.5KV
ESD Voltage Protection, Machine Model.....	250 V

### Caution:

Stress exceeding maximum ratings may damage the device. Maximum ratings are stress ratings only. Functional operation above the recommended operating conditions is not implied. Extended exposure to stress above recommended operating conditions may affect device reliability.

## Recommended Operating Conditions<sup>\*Note1</sup>

Item	Min.	Max.	Unit
Supply VCC Voltage	15	56	V
Operating Junction Temperature	-40	125	°C
Resistor of ISET pin	33	330	kΩ
Source Current of DIM pin	-	300	μA
Input voltage of DIM pin	0	13	V
Input PWM frequency of DIM pin	0.5	5	kHz
Capacitor of DIM pin( $C_{DIM}$ ) <sup>*Note2</sup>	330	1000	pF
Resistance of DIM pin( $R_{DIM}$ ) <sup>*Note2</sup>	1	6.5	kΩ
PWM Signal Input Rising and Falling Time Rate	3	-	V/μs
High Voltage Level PWM Signal Input on DIM pin	3.2	13	V
Low Voltage Level PWM Signal Input on DIM pin	-	1.2	V
Sink current of OUT pin	-	20	mA

### Note:

1. It's essential to connect VCC pin with a SMD ceramic capacitor (0.1μF~0.47μF) to filter out the undesired switching noise for stable operation. This capacitor should be placed close to IC pin as possible.
2. Test condition is  $R_{ISET}=100K\Omega$ . (This mean is  $I_{DIM}=100\mu A$ ), and base on leadtrend's patent for PWM input mode.
3. This application is based on system operation condition. Please refer to electrical characteristic information or contact us.

**Electrical Characteristics**

 ( $V_{CC}=32.0V$ ,  $T_A = 25^{\circ}C$  unless otherwise specified.)

PARAMETER	CONDITIONS	SYMBOL	MIN	TYP	MAX	UNITS
<b>Supply Voltage (VCC Pin)</b>						
UVLO (ON)		$V_{CC\_ON}$	6.0	7.0	8.0	V
UVLO (OFF)		$V_{CC\_OFF}$	5.2	6.0	6.8	V
Operating Current	$R_{ISET}=100k\Omega$ , DIM pin and CLAMP pin is floating.	$I_{VCC}$		600	850	$\mu A$
<b>ISET Pin</b>						
Open Voltage	ISET pin is floating	$V_{ISET\_OPEN}$	2.45	2.5	2.55	V
Current Ratio of $I_{DIM}$ to $I_{SET}$ ( Calculate $I_{DIM}/I_{SET}$ )	*	$K_{DIM}$		4		
Current Ratio of $I_{CLAMP}$ to $I_{SET}$ ( Calculate $I_{CLAMP} / I_{SET}$ )	*	$K_{CLAMP}$		0.4		
<b>DIM Pin (Dimming function)</b>						
Open Voltage	$R_{ISET}=100k\Omega$ , DIM pin is floating.	$V_{DIM\_OPEN}$	12.2	13	13.8	V
Maximum on level	Output duty =100%	$V_{DIM\_MAX\_ON}$	10.0	10.2	10.4	V
Zero Duty on OUT pin	Output duty $\leq 1\%$	$V_{DIM\_0\%}$		1.5		V
Bias Current	$R_{ISET}=100k\Omega$ ;	$I_{DIM\_100}$	97	100	103	$\mu A$
High Level of PWM input signal	*	$V_{DIM\_PWM\_H}$	3.2			V
Low Level of PWM input signal	*	$V_{DIM\_PWM\_L}$			1.2	V
PWM Dimming Mode Setting	*;Trigger rising rate and continuous 8 times	Slew	3			$V/\mu s$
<b>CLAMP Pin ( Clamping min. dimming )</b>						
Open Voltage	$R_{ISET}=100k\Omega$ , Clamp pin is floating.	$V_{CLAMP\_OPEN}$	4.7	5.0	5.3	V
Minimum Duty Cycle Clamp  Note: When $R_{ISET}=100K \Omega$	*; $R_{CLAMP} \geq 1M \Omega$ or Open $V_{CLAMP} \geq 4.2V$ and $V_{DIM}=1.6V$	$D_{OUT\_0\%}$		1	2.5	%
	$R_{CLAMP} = 300k \Omega$ ; $V_{CLAMP} = 2.6V$ to $3.6V$ and $V_{DIM}=0V$	$D_{OUT\_4\%}$	2	4	6	%
	$R_{CLAMP} = 150k \Omega$ ; $V_{CLAMP} = 1V$ to $2V$ and $V_{DIM}=0V$	$D_{OUT\_6\%}$	4	6	8	%
	$R_{CLAMP} = 0 \Omega$ ; $V_{CLAMP} \leq 0.5V$ and $V_{DIM}=0V$	$D_{OUT\_8\%}$	6	8	10	%

( $V_{CC}=32.0V$ ,  $T_A = 25^{\circ}C$  unless otherwise specified.)

PARAMETER	CONDITIONS	SYMBOL	MIN	TYP	MAX	UNITS
<b>Open Drain Output Set (OUT Pin)</b>						
Output Low Level	@2mA sink current	$V_{OUT\_LOW}$			200	mV
Dimming accuracy of Duty (Chip to Chip)	*; During DIM Voltage is from 2.0V to 9.0V	D.A	-2.5		+2.5	%
Output Frequency		$F_{OUT}$	1.0	1.5	2.0	kHz
<b>Internal OTP (Over Temp. Protection)</b>						
OTP Trip level	*	OTP		135		$^{\circ}C$
OTP Hysteresis	*	$\Delta OTP$		20		$^{\circ}C$

\*: Guaranteed by design.

Typical Performance Characteristics

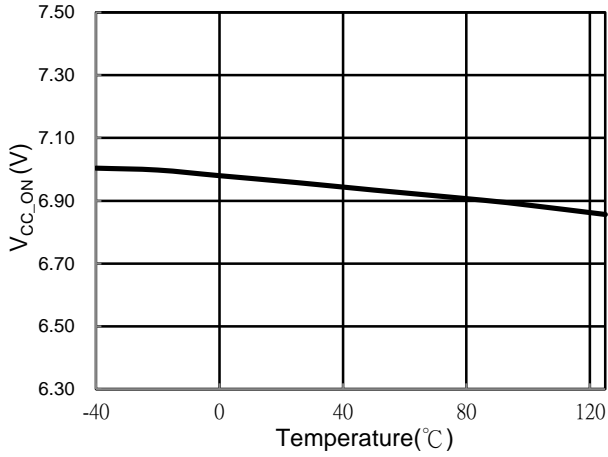

Fig.2 V<sub>CC\_ON</sub> VS. Temperature

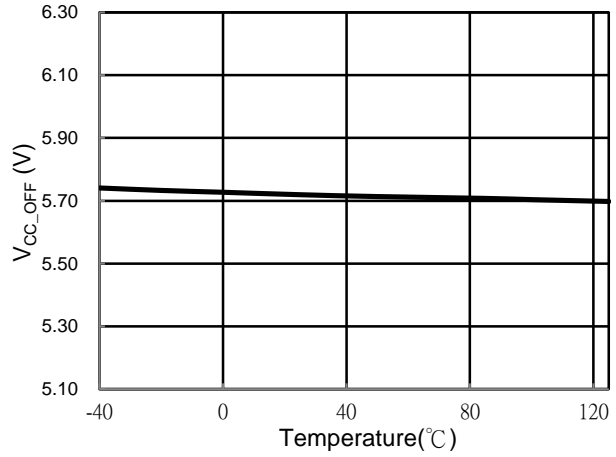

Fig.3 V<sub>CC\_OFF</sub> VS. Temperature

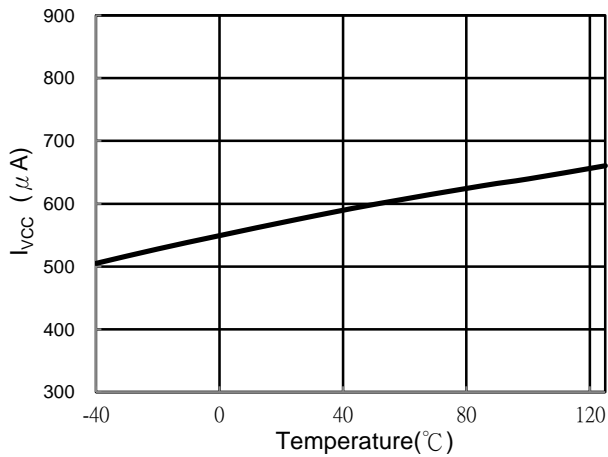

Fig.4 I<sub>VCC</sub> VS. Temperature

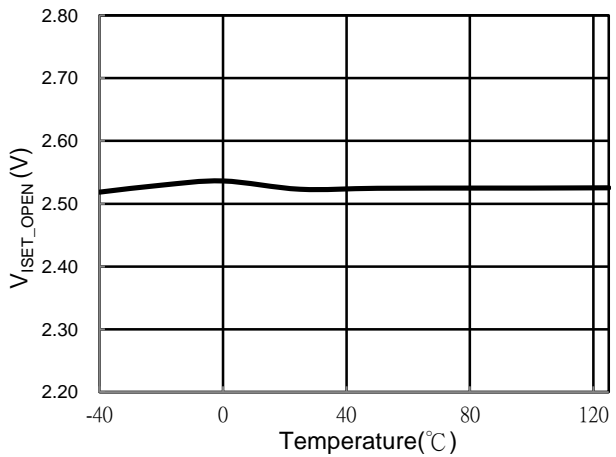

Fig.5 V<sub>ISET\_OPEN</sub> VS. Temperature

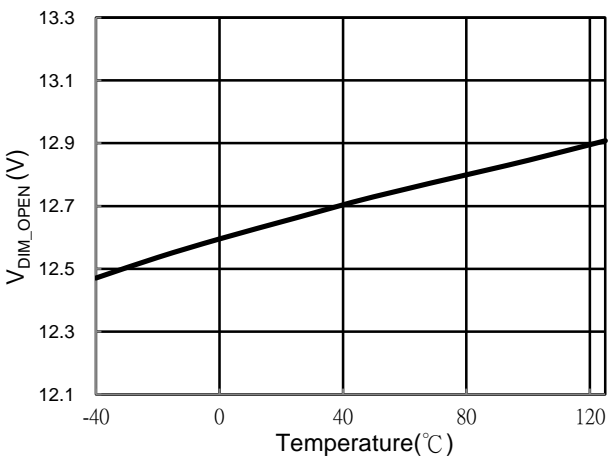

Fig.6 V<sub>DIM\_OPEN</sub> VS. Temperature

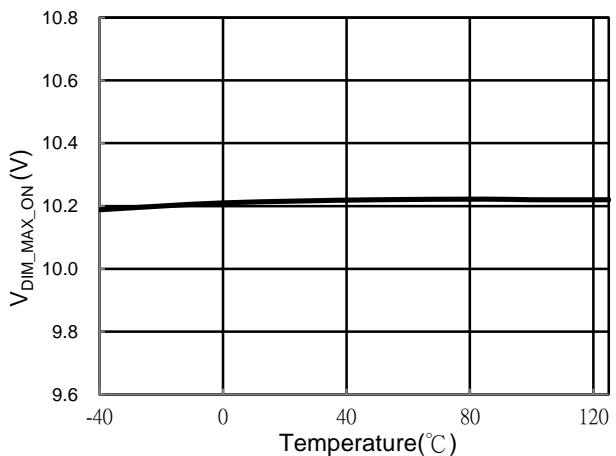

Fig.7 V<sub>DIM\_MAX\_ON</sub> VS. Temperature

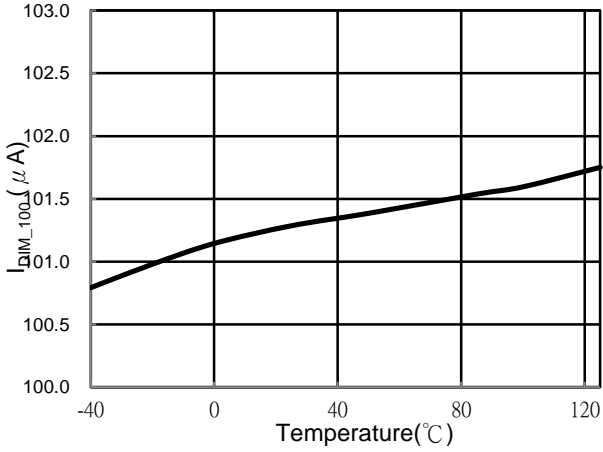

Fig.8 I\_DIM\_100 VS. Temperature

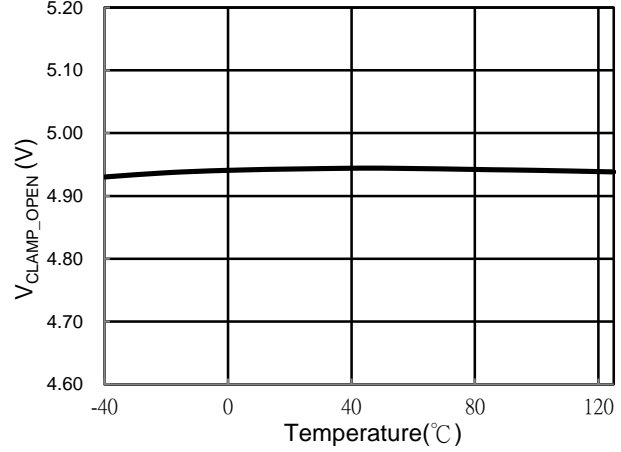

Fig.9 V\_CLAMP\_OPEN VS. Temperature

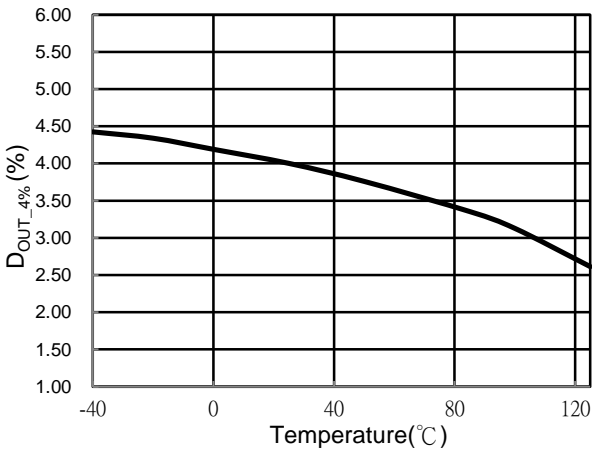

Fig.10 D\_OUT\_4% VS. Temperature

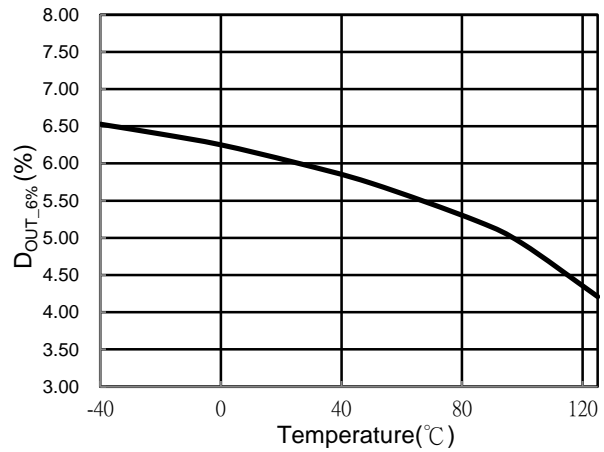

Fig.11 D\_OUT\_6% VS. Temperature

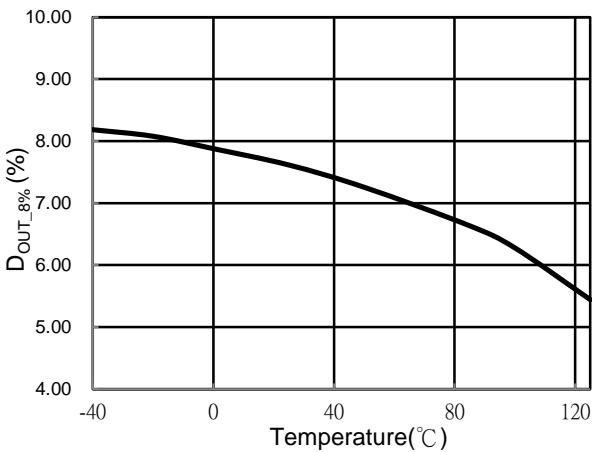

Fig.12 D\_OUT\_8% VS. Temperature

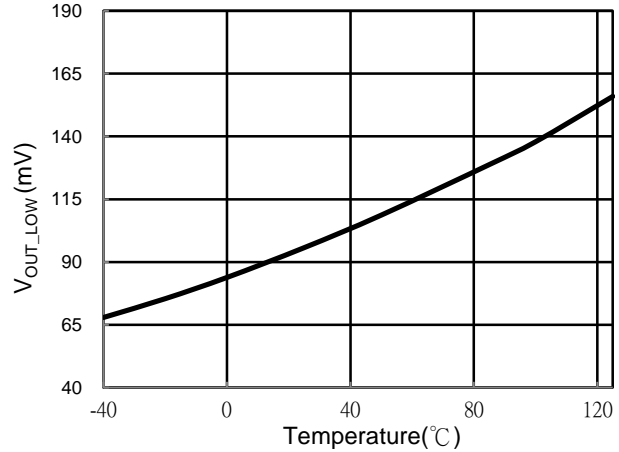

Fig.13 V\_OUT\_LOW VS. Temperature



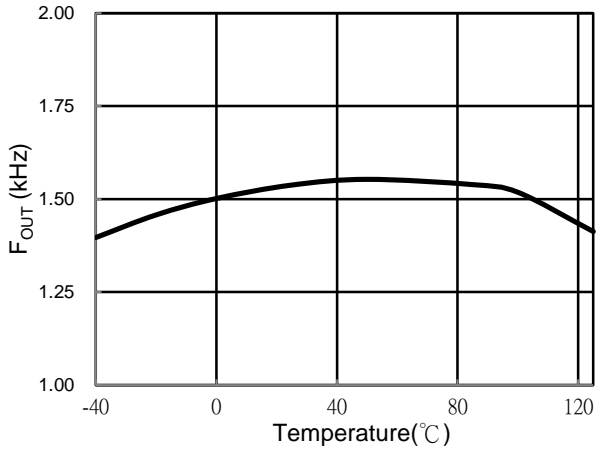

Fig.14 F<sub>OUT</sub> VS. Temperature

## Application Information

### Operation Overview

The LD8116B is an excellent 3 in 1 dimming controller for LED lighting applications. It integrates more functions to reduce the external components counts and the size. Its major features are described as below.

The LD8116B convert input DC potential or PWM signal into PWM output. The output of LD8116B is an open-drain configuration which can pull down any source directly to control power supply dimming. The DIM pin of LD8116B provides an adjustable bias current for potentiometer. So LD8116B can satisfy with active and passive dimmers both. It also can be used in isolation application with opto-coupler.

### Startup and Under Voltage Lockout (UVLO)

An UVLO comparator is embedded to detect the voltage on the VCC pin to ensure the supply voltage enough to power on the LD8116B. The turn on and turn off threshold voltage is fixed at 7V and 6V. When the voltage of VCC pin is above 6V, the LD8116B output PWM which is basing on input DC potential, PWM single or potentiometer.

### Bias Current of DIM Pin

ISET pin of LD8116B is used to set bias current source of DIM pin by a resistor (= R<sub>ISET</sub>) on ISET pin which is connected to GND. For the typical application, the output bias current of DIM pin is 100 μA when R<sub>ISET</sub> is 100k ohm. The relationship between resistor and output bias current is:

$$I_{DIM} = \frac{2.5V}{R_{ISET}} \times K_{DIM}$$

Where, K<sub>DIM</sub> is a coefficient of current ratio of I<sub>DIM</sub> per I<sub>SET</sub>. The resistance range of R<sub>ISET</sub> is recommend from 33k to 330k ohm and the range of bias current is approach to 30 μA ~ 300 μA.

### Minimum Output Duty Cycle

When the input of DIM pin is DC potential, CLAMP pin of LD8116B can be setting minimum output duty cycle by a resistor (= R<sub>CLAMP</sub>) on CLAMP pin which is connected to GND. There are four modes for user to select. Please refer to the below table1. The relationship between resistor and voltage of clamp pin is:

$$V_{CLAMP} = I_{CLAMP} \times R_{CLAMP} = \frac{2.5V}{R_{ISET}} \times K_{CLAMP} \times R_{CLAMP}$$

Where, K<sub>CLAMP</sub> is a coefficient of current ratio of I<sub>CLAMP</sub> per I<sub>SET</sub>.

V <sub>CLAMP</sub> (V)	Suggestion R <sub>CLAMP</sub> (Ω)	Minimum output Duty Clamping
	When R <sub>ISET</sub> =100KΩ	
< 0.5	0 (Short)	8%
1~2	150k	6%
2.6~3.6	300k	4%
> 4.2	> 510k (Open)	No clamping

Table1: Minimum output duty cycles clamping Selection

### Dimming Performance

#### 0~10V Potential Dimming

When the input signal of DIM pin is DC potential, LD8116B will transfer to PWM signal output at OUT pin. The frequency of output PWM on OUT pin is 1.5kHz around. Typical dimming curve is from 1.5V to 10.2V transfer to 0~100% output duty.

#### PWM Dimming (Leadtrend 's patent pending)

During PWM signal input on the DIM pin, the output of LD8116B OUT pin is PWM, too. And the output frequency and duty of OUT pin is following the input PWM frequency and duty directly. The input amplitude of PWM signal has to high level higher or equal to 3.2V and low level less than 1.2V on DIM pin. And recommend PWM frequency range is from 500Hz to 5kHz. ICs detect the PWM rising slew rate of DIM pin is faster than 3 V/μs through 1.2V to 3.2V and continuous

8 cycles become into PWM dimming mode. If PWM rising slew rate of DIM pin is larger than  $3\text{ V}/\mu\text{s}$ , ICs will reset cycles counter. Once into PWM dimming mode, it will keep dimming mode until VCC is reset by UVLO\_off.

#### **Potentiometer Dimming**

When DIM pin is connected a potentiometer to GND, bias current source of DIM pin is pass thought this potentiometer then cause a DC voltage potential on DIM pin, LD8116B will transfer to PWM signal output on OUT pin. The frequency of PWM signal on OUT pin is 1.5kHz around.

#### **Internal Over Temperature Protection**

When internal over temperature protection is occur ( $135^{\circ}\text{C}$  typ.). The OUT pin of LD8116B is open drain and auto-recovery after thermal down to normal operating temperature.

#### **Optocoupler Selection Guide**

LD8116B converts an analog dimming signal into a PWM waveform. In the majority of applications the dimming signal needs to be isolated from the rest of the application and an optocoupler is used to implement either functional or reinforced isolation. Optocouplers are an excellent choice since they are very cost effective but nevertheless able to comply with virtually all safety standards. The most common and cost effective optocouplers are four-pin devices consisting of a LED and a photosensitive BJT. With four pin devices only collector and emitter of the BJT are connected to pins. This limits device performance, especially switching times, as will be discussed later. Six-pin devices having the base of the BJT as well connected to a pin are seen less often. With these six-pin devices bandwidth of the transmission can be improved if necessary. Finally there are high-speed digital couplers available that are designed for very high data rates and offer a buffered output with a nearly perfect PWM signal. While offering superior performance high speed couplers are

considerably more expensive than simple LED-BJT couplers.

There are two parameters of an optocoupler that are most important for use with LD8116B: the current transfer ratio CTR and the switching times  $T_r$  and  $T_f$ .

A typical plot of  $T_r$  and  $T_f$  vs.  $R_L$  taken from the data sheet of a widely used 4-pin optocoupler.

## Package Information

### SOT-26

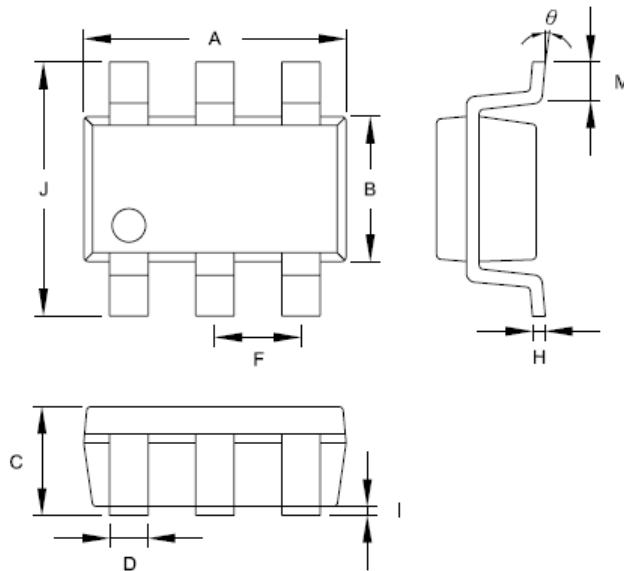

Symbol	Dimension in Millimeters		Dimensions in Inches	
	Min	Max	Min	Max
A	2.692	3.099	0.106	0.122
B	1.397	1.803	0.055	0.071
C	-----	1.450	-----	0.057
D	0.300	0.500	0.012	0.020
F	0.95 TYP		0.037 TYP	
H	0.080	0.254	0.003	0.010
I	0.050	0.150	0.002	0.006
J	2.600	3.000	0.102	0.118
M	0.300	0.600	0.012	0.024
θ	0°	10°	0°	10°

### Important Notice

Leadtrend Technology Corp. reserves the right to make changes or corrections to its products at any time without notice. Customers should verify the datasheets are current and complete before placing order.

**Revision History**

REV.	Date	Change Notice
00	08/03/2018	Original Specification